



TPS980T

Quick Start Guide

Version: 1.1

Date: Mar. 2020

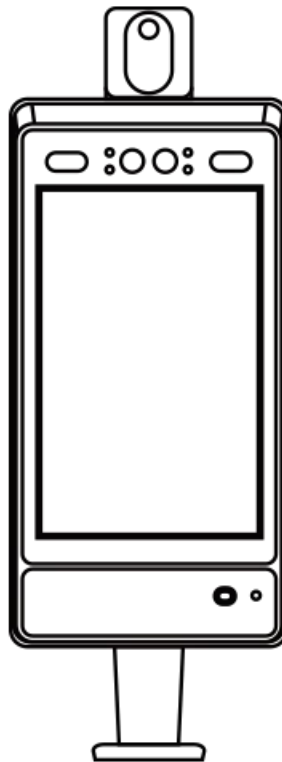

Telepower Communication Co., Ltd.

Notice

our company owns the copyright of all content contained in this guide. Without our company's permission, the content shall not be reproduced, modified or used in any form.

As the product is updated regularly, we cannot guarantee the consistency of the actual product with the contents of the manual. Our company is not responsible for any disputes and liabilities caused by the differences between the actual technical parameters and this guide.

The manual is subject to change without prior notice.

Contents

- 1 Overview.....4**
- 2 Device Installation..... 4**
 - 2.1 Wall Mounted..... 4
 - 2.2 Turnstile Mounted..... 6
 - 2.3 Height and Angle..... 7
 - 2.4 Cable Connection..... 7
- 3 Using Tips..... 9**
 - 3.1 Distance for Temperature Measurement..... 9
 - 3.2 Body Part for Temperature Measurement..... 9
 - 3.3 Cautions for Temperature Measurement..... 9
- 4 User Registration..... 10**
 - 4.1 WEBSITE..... 10
 - 4.2 Register from Cloud..... 10
 - 4.2.1 Login Account..... 10
 - 4.2.2 Add Device..... 10
 - 4.2.3 Add Department..... 11
 - 4.2.4 Add Positions..... 11
 - 4.2.5 Add Member..... 12
 - 4.2.6 Synchronize Member to Device..... 12
 - 4.3 Register from Device..... 14
 - 4.3.1 Preparation..... 14
 - 4.3.2 Add member..... 14
- 5 Face Recognition and Temperature Measurement..... 16**
- 6 Time Attendance..... 17**
 - 6.1 Work Time Management..... 17
 - 6.2 Attendance Management..... 17
 - 6.3 Attendance Records..... 18

1 Overview

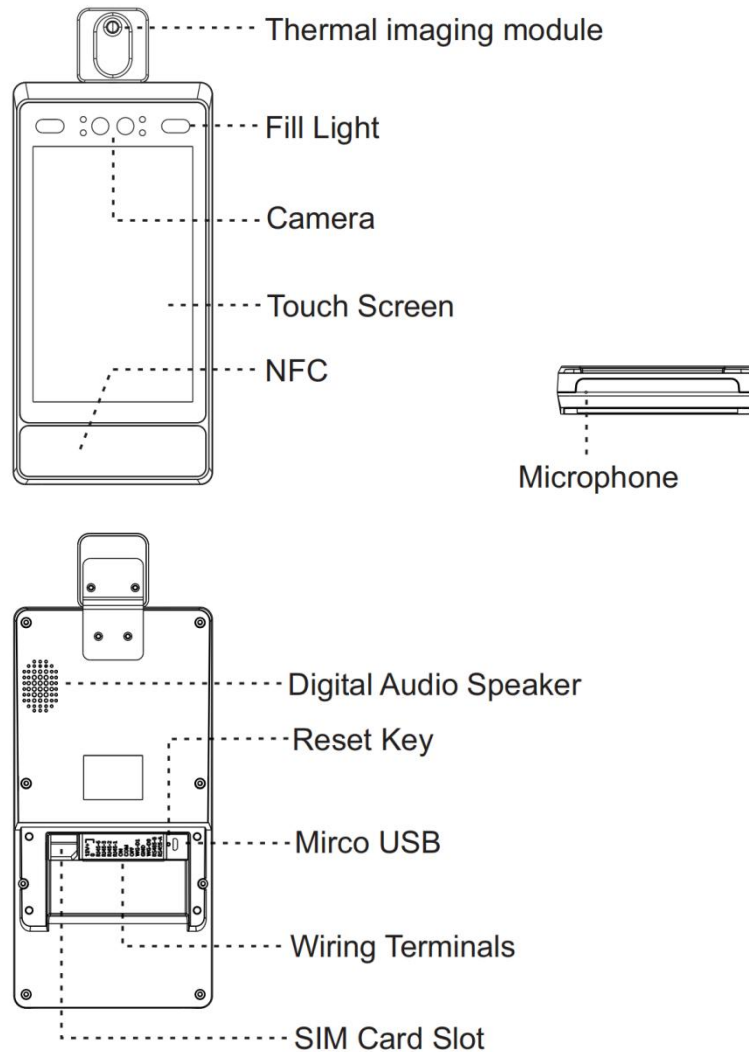

2 Device Installation

2.1 Installation environment

To ensure the temperature measurement accuracy of the equipment, the installation environment has the following requirements.

- Equipment installation indoor environment.
- The equipment should not be directly facing the air conditioner and fan, avoid direct sunlight, and require no obvious rapid temperature change environment.

2.2 Precautions for Use

Temperature detection distance:

- The best distance for temperature measurement: the detection temperature is between 0.5-0.7 m with high accuracy, and the accuracy decreases if the temperature exceeds this range.

Body temperature detection:

- To ensure the accuracy of temperature detection, temperature detection is performed on the forehead.

Matters needing attention for temperature detection:

- Temperature measuring equipment should be used in a room with no ventilation and room temperature between 15°C and 35°C (59°F~95°F).
- The device should be started for 10 minutes after the sensor temperature and ambient temperature are balanced.
- When measuring temperature, the forehead should be directly facing the forehead of the temperature measuring area to ensure the accuracy of the measuring area.
- During temperature measurement, forehead position should be kept fixed to avoid temperature change caused by forehead position change.
- The measurement should be made with no cover on the forehead (hat, hair) and no sweat on the forehead.
- Don't cover your forehead with cold water or warm water before measurement.
- When measuring temperature, avoid to temporarily put down the mask or glasses test, to avoid sudden change of temperature.
- After drinking hot water, after meals, after naps, after exercise, you need to measure the temperature 30 minutes later.
- Exposure to certain factors, such as showers, hair dryers and sprays, can change the temperature of the forehead.
- The temperature measurement accuracy will be affected when people enter the room from the cold outdoor environment. The temperature can be measured again through the passage of 10-20m drainage belt or after the body temperature stabilizes.

2.3 Wall Mounted

- Drill holes on the wall or other surface according to the mounting plate.
- Use four supplied self-tapping screws to secure the mounting plate on the wall.
- Route the cables through the cable hole of the mounting plate and bracket, and connect to the wiring terminals.
- Plug the wiring terminals into the device and use four supplied M5 screws to secure the bracket on the device.
- Align the device with the mounting plate and buckle them together, and use two supplied M3 screws to secure the device on the mounting plate.

- Adjust the tilt angle of the device according to your actual needs.

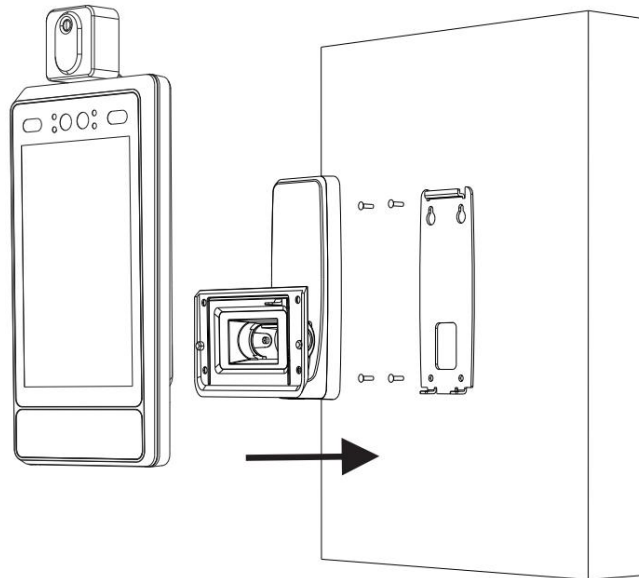

2.4 Turnstile Mounted

- Thread the cable through the nut, the cable holes on the turnstile pedestal's top panel, and route them through the bracket.
- Wire the cable with the terminals in the turnstile pedestal.
- Raise the bracket and make sure the bracket and the pedestal top panel are vertical.
- Rotate the nut and secure the bracket.
- Plug the wiring terminals into the device and use four supplied M5 screws to secure the bracket on the device.
- Adjust the tilt angle of the device according to your actual needs.

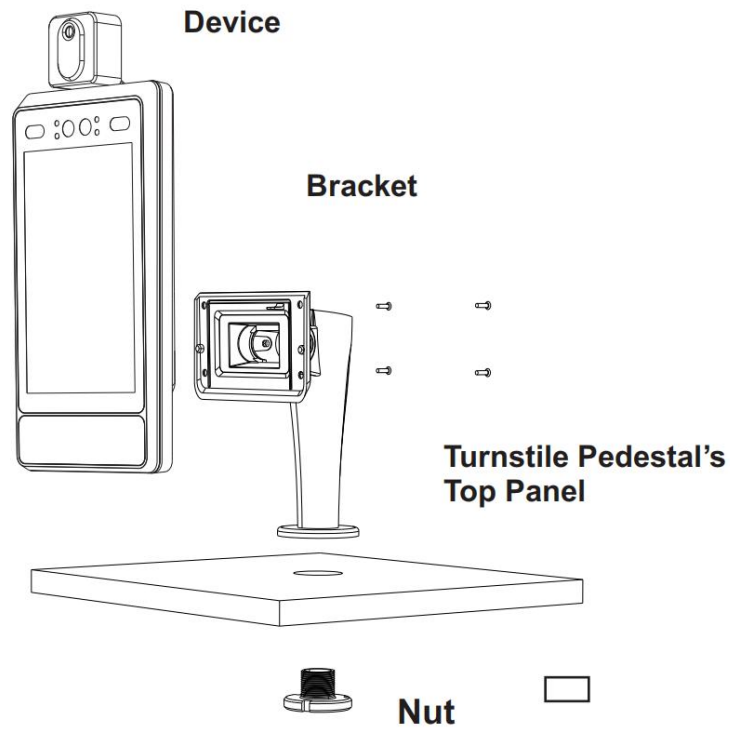

2.5 Height and Angle

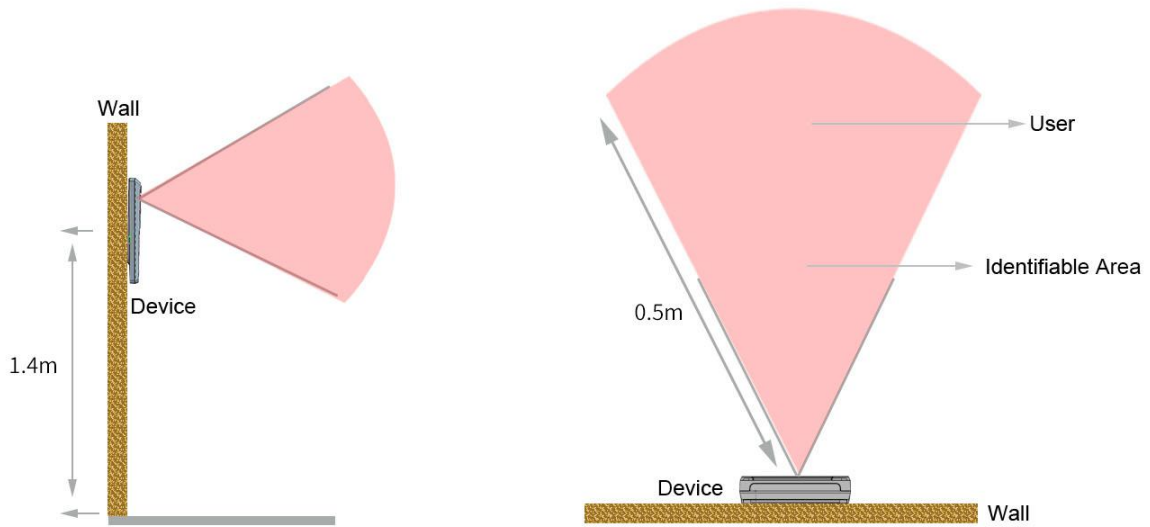

2.6 Cable Connection

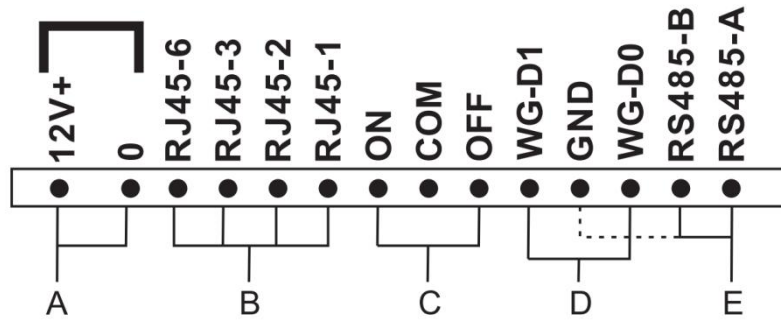

Group	Function	Color	Name
A	Power Input	Red (Thick) × 2	12V+
		Black (Thick) × 2	0
B	RJ45	Grey	RJ45-6
		Yellow	RJ45-3
		Orange	RJ45-2
		Brown	RJ45-1
C	Door Lock	Blue (Thick)	ON
		Green (Thick)	COM
		Yellow (Thick)	OFF
D	Wiegand	Blue	WG-D1
		Red	WG-D0
E	RS485	Black	GND
		Green	RS485-B
		White	RS485-A

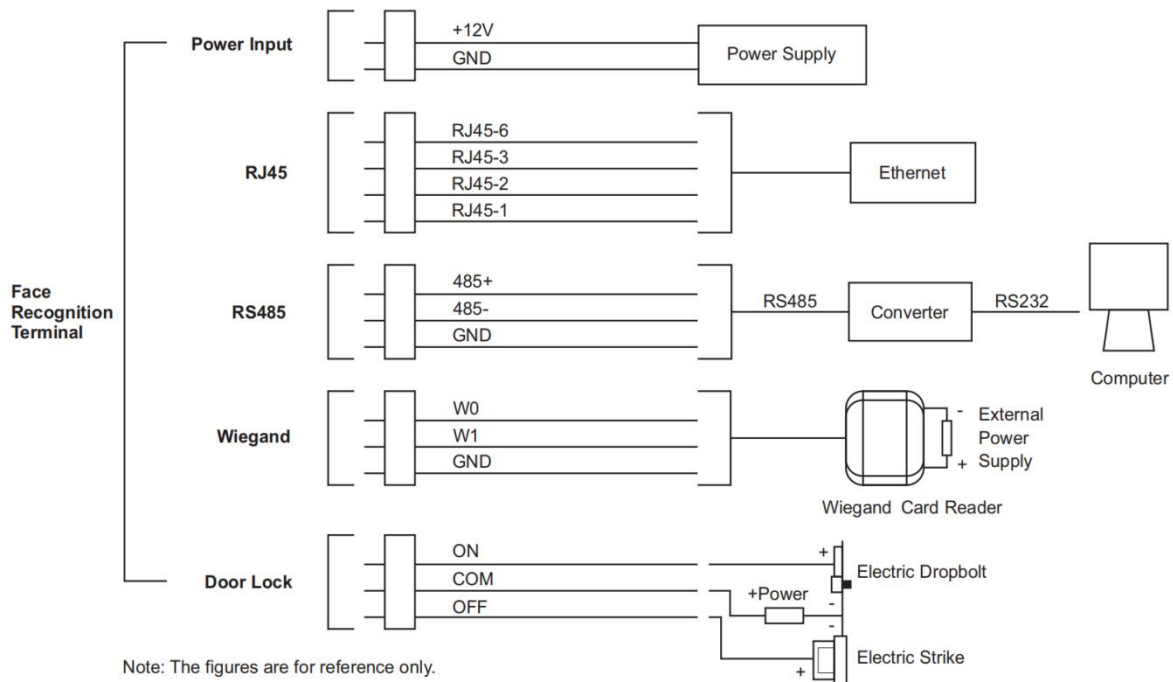

3 Using Tips

3.1 Distance for Temperature Measurement

- Best distance for temperature measurement: 0.5m.
- Recommended distance for temperature measurement is 0.4m to 0.6m. Otherwise the precision will be affected as the distance is reduced or increased.

3.2 Body Part for Temperature Measurement

- In order to guarantee the accuracy of temperature detection, the temperature measurement area is the forehead area.

3.3 Cautions for Temperature Measurement

- To ensure the exact measuring area, the forehead position is required to be on the right place of the face frame on the TPS980 LCD when measuring temperature.
- **DO NOT** move your forehead when measuring temperature.
- Ensure there is no shield (such as hat, hair) or sweat on the forehead when measuring temperature.
- **DO NOT** use cold water or hot water on the forehead before measuring temperature.
- **DO NOT** suddenly take off the mask or glasses when measuring temperature.
- Please wait 30 minutes to measure temperature after drinking hot water/having a meal/sleeping/taking exercise.

4 User Registration

4.1 Website

This document is for online version of Telpo Face. In this case, TPS980T device is connected with Cloud.

- Please get account and password from Telpo team.
- Open web site: <https://face.telpocloud.com>
- Please register member's face information via either Cloud mode or Device mode.

4.2 Register from Cloud

NOTICE: If already registered from TPS980 device, no need to register from cloud again.

4.2.1 Login Account

Login account on <https://face.telpocloud.com>

4.2.2 Add Device

Register device SN on cloud.

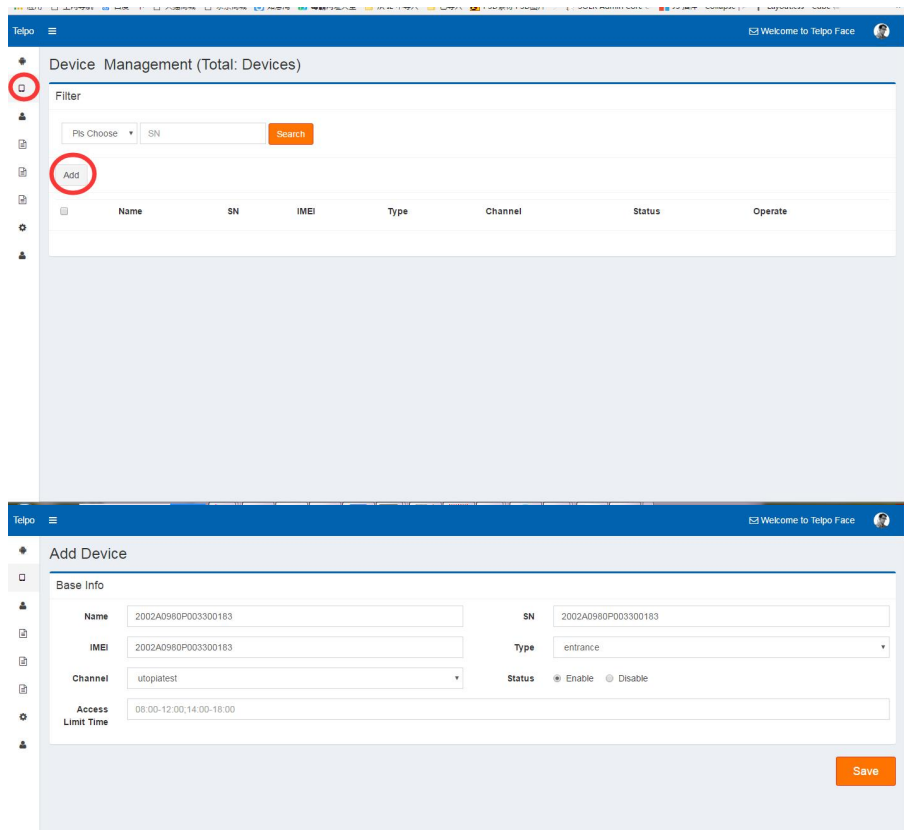

(1) Make sure Sn is right.

(2) Access Limit time means you can set the time area you can access.

4.2.3 Add Department

When you add the sub-department, you need to select the parent department and click the add button.

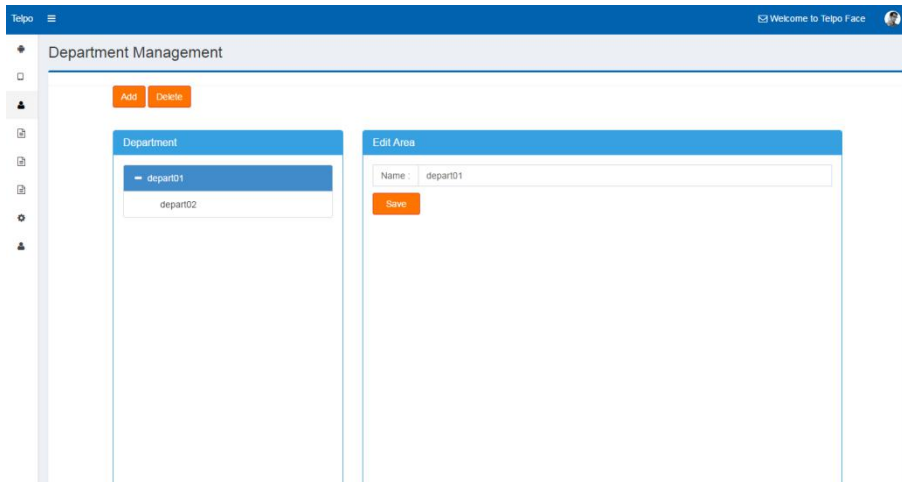

4.2.4 Add Positions

In this page, you can add/update/delete Positions.

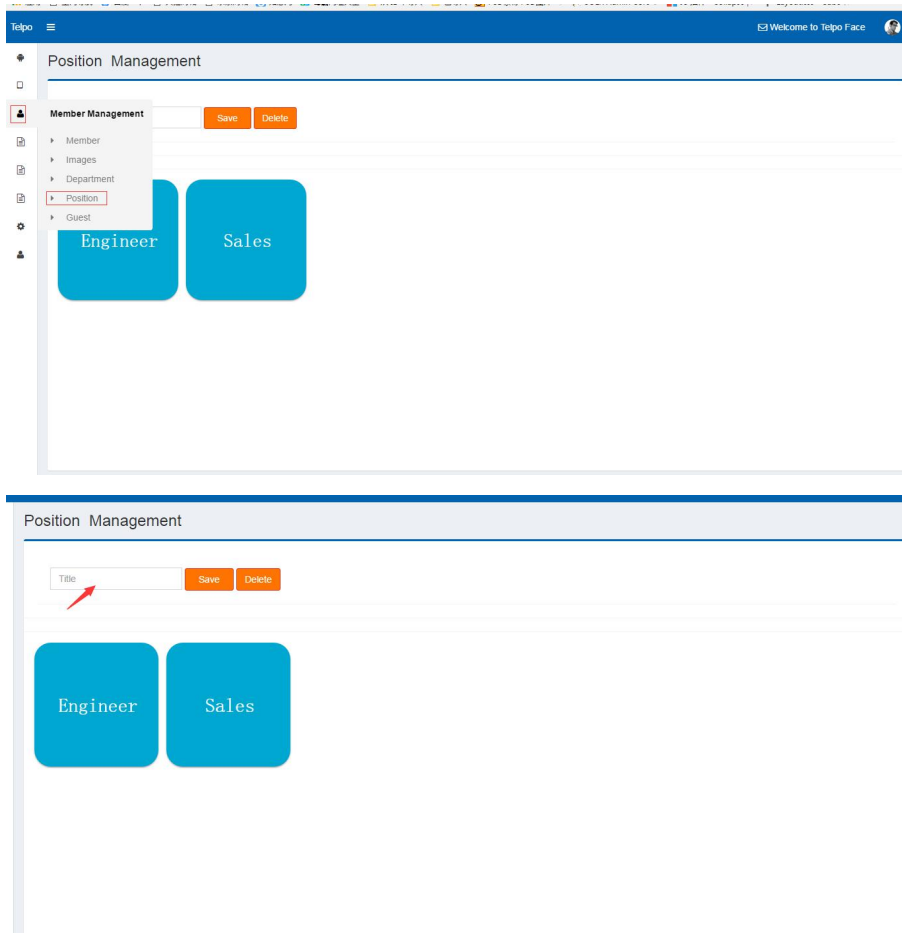

4.2.5 Add Member

In this page, you can add/update member photo and information.

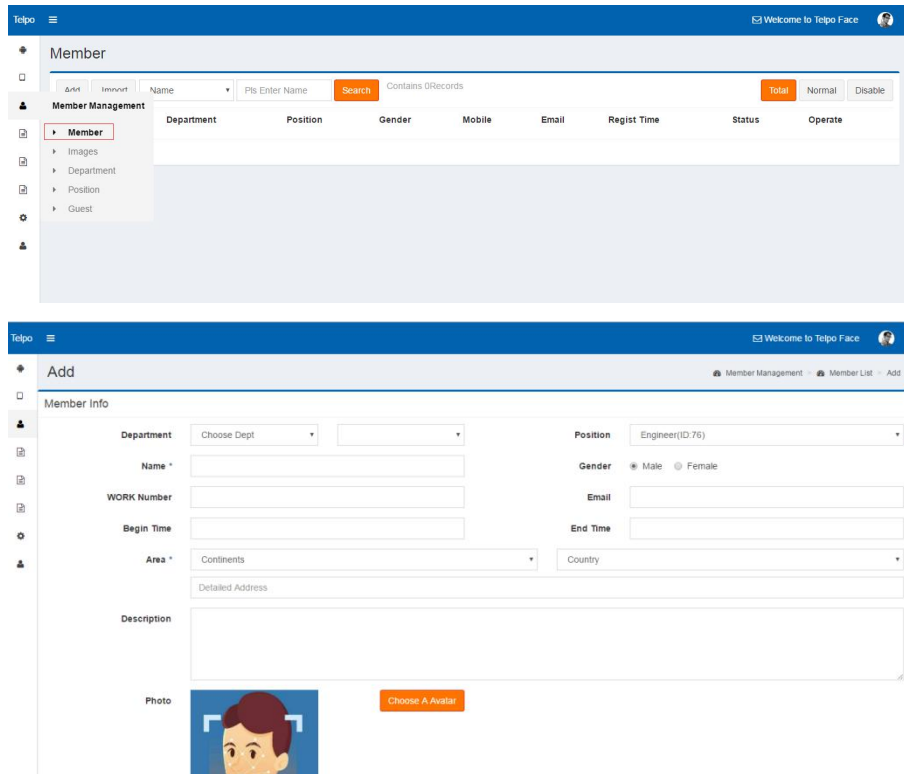

4.2.6 Synchronize Member to Device

(1) Click the left top icon and input the default password “telpo” enter the admin panel in TPS980T.



(2) Click the “Activate” button to active device first. Then go to Data management.

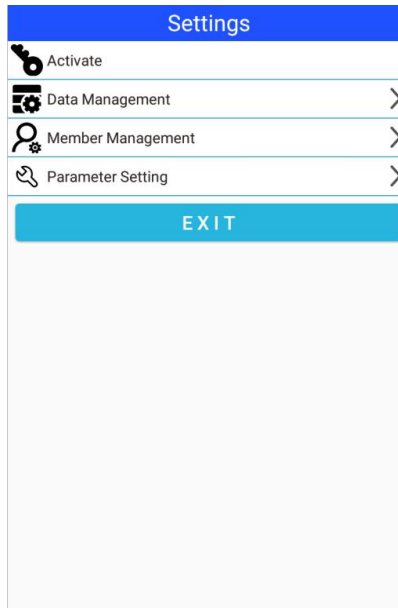

(3) The “Auto update” open means device will auto check update every 10 minutes from server.

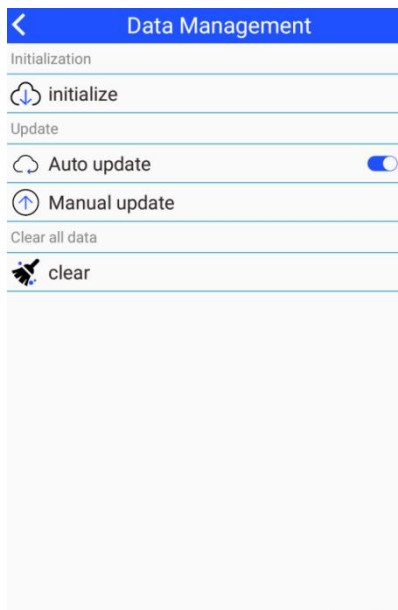

(4) Click the “Initialize” button to sync member from server.

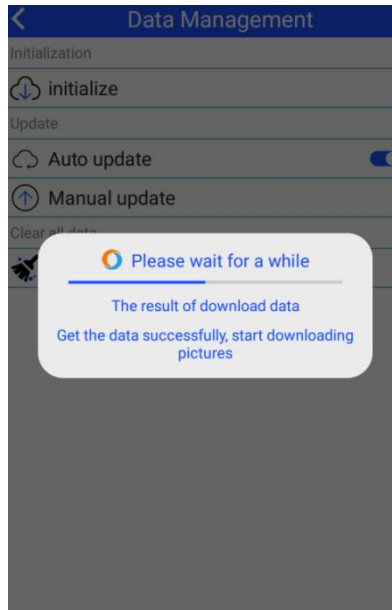

(5) After sync complete, you can go to “Data Management” to check the members you download from server.

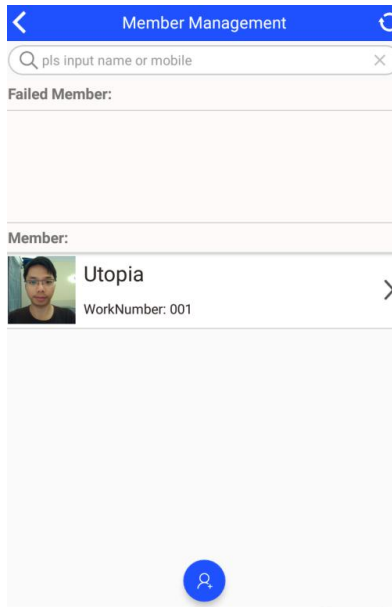

4.3 Register from Device

NOTICE: If already registered from cloud, no need to register from TPS980T device again.

4.3.1 Preparation

Please follow chapter 4.2.1 and 4.2.2 to add device first.

4.3.2 Add member

(1) Click the left top icon and input the default password “telpeo” enter the admin panel in TPS980T.

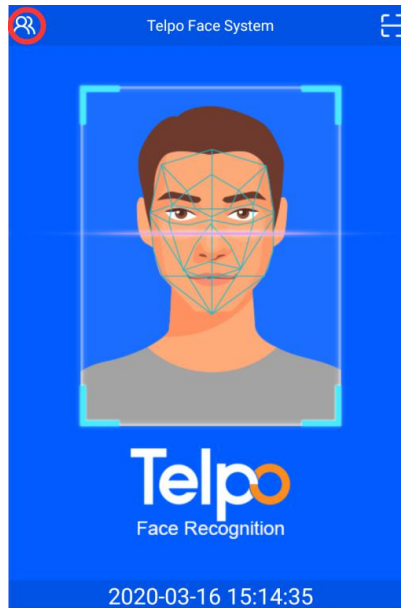

(2) Click the "Member Management" button.

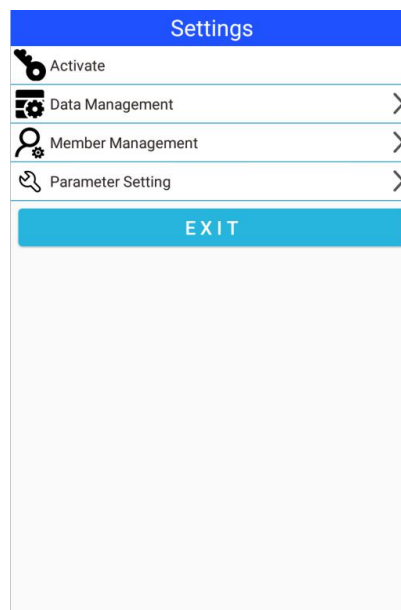

(3) Click the bottom blue button to add a member from device.

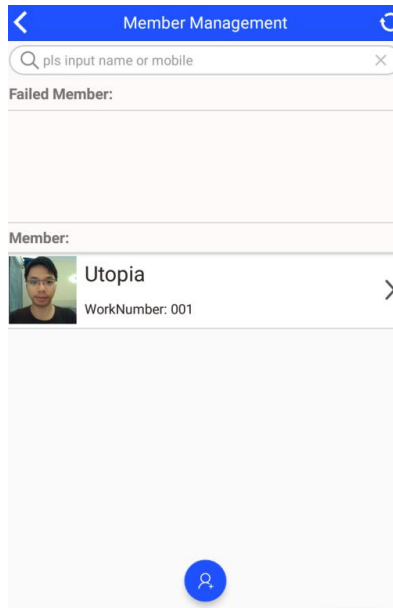

(4) Add information as below, including photo, user name, user ID, valid time. Then click "Register".

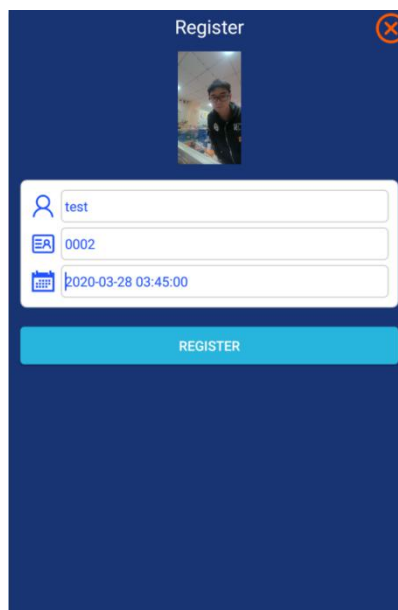

5 Face Recognition and Temperature Measurement

After registering, please stand in front of TPS980 and you will see the successful result as below.

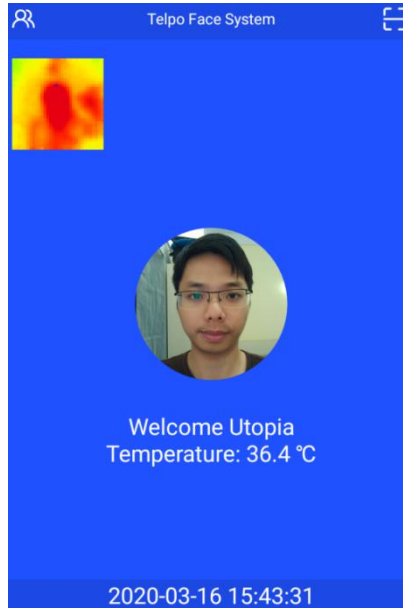

6 Time Attendance

If you need to use the time attendance function, please login website and check below functions.

6.1 Work Time Management

Manage your work time.

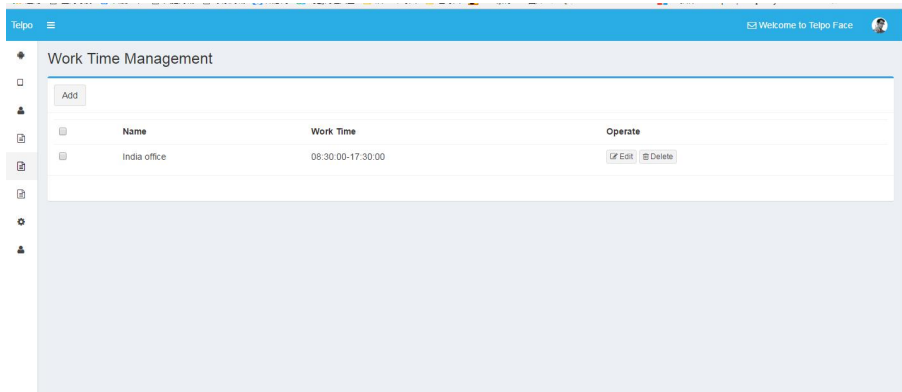

6.2 Attendance Management

To manage your attendance group. You can select the members to this group.

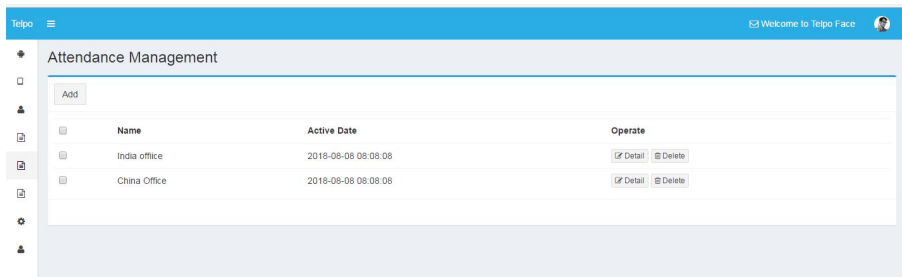

6.3 Attendance Records

All attendance records are shown here. You can select data and export as excel.

Name	Attendance Time	Attendance Day
test	15:48:29,15:48:29,15:48:27,15:48:40	2020-03-16
Utopia	15:45:21,15:43:28,15:44:37,15:45:00,15:49:07,15:49:16	2020-03-16



Simple | Smart | Secure

Telepower Communication Co., Ltd

www.telpo.com.cn

Tel: +(00)86-757-86227898

Email: business@telpo.com

Add: Foshan City, Guangdong Province, China